

Pola One

The radiator has a built-in ONE heating element.

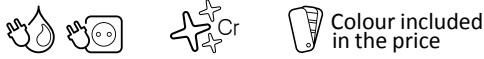

design: *Terma*

Connections:

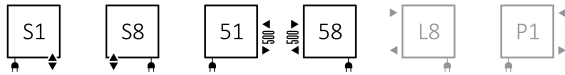

Electric radiators:

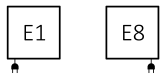

We recommend:

A set of integrated thermostatic valves with immersion tube for S1 and S8 connections



Integrated pipe-masking set



Available sizes:

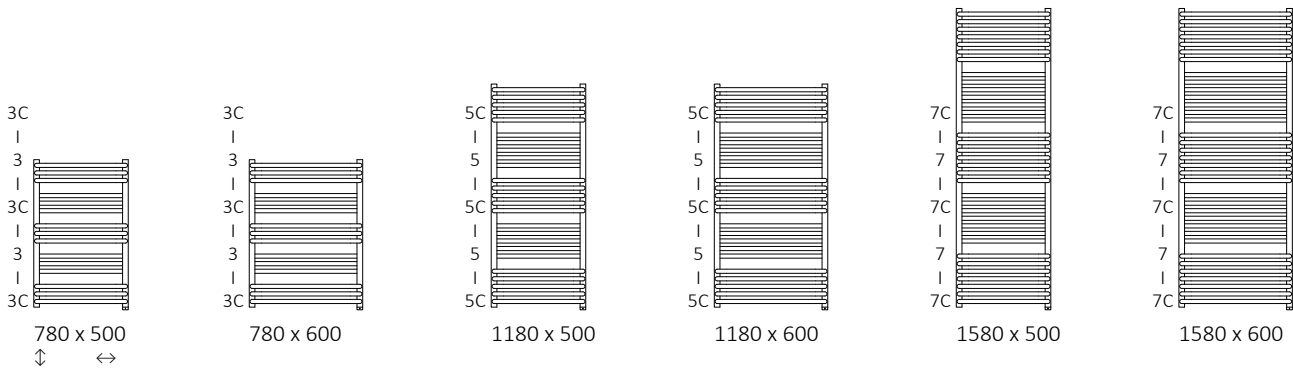

Specifications:

Working pressure: 1,0 MPa Maximum operating temperature: 82°C

A ↓	B ↔	C5 [mm]	75/65/20°C [W]	55/45/20°C [W]	 [W]	D [mm]	E [mm]	F [mm]	 [dm³]	 [kg]	Product Code <small>Configuration codes: 3</small>
Powder coating											
780	500	500	392	211	400	470	640	70	3,27	6,72	WZPAN078050
780	600	500	471	254	400	570	640	70	3,72	7,68	WZPAN078060
1180	500	500	638	342	600	470	1040	70	5,33	10,84	WZPAN118050
1180	600	500	766	411	800	570	1040	70	6,07	12,44	WZPAN118060
1580	500	500	883	473	800	470	1440	70	7,38	14,96	WZPAN158050
1580	600	500	1061	568	1000	570	1440	70	8,42	17,20	WZPAN158060
Plated finishes											
780	500	500	274	140	300	470	640	70	3,27	6,72	WZPAN078050
780	600	500	330	168	300	570	640	70	3,72	7,68	WZPAN078060
1180	500	500	447	228	400	470	1040	70	5,33	10,84	WZPAN118050
1180	600	500	536	273	600	570	1040	70	6,07	12,44	WZPAN118060
1580	500	500	618	315	600	470	1440	70	7,38	14,96	WZPAN158050
1580	600	500	743	379	800	570	1440	70	8,42	17,20	WZPAN158060

Pola One

The radiator has a built-in ONE heating element.

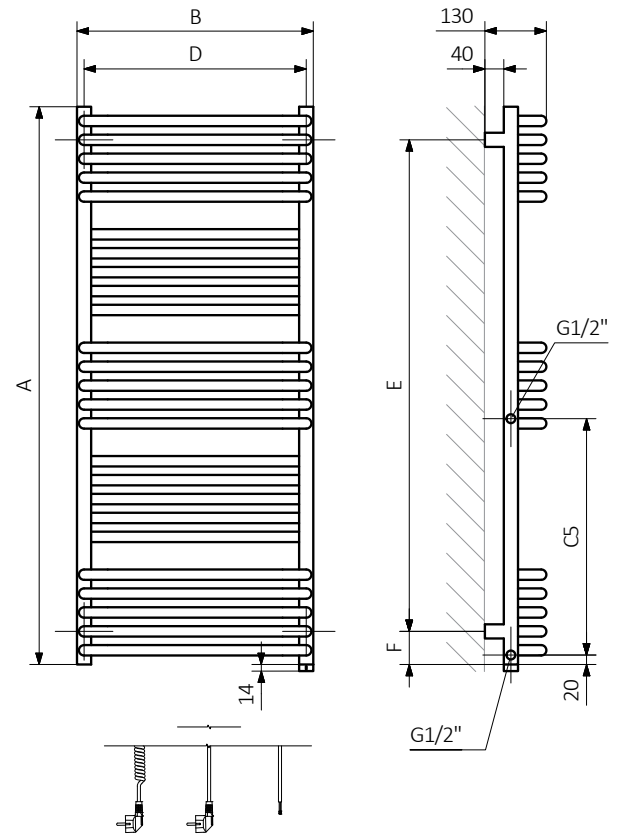
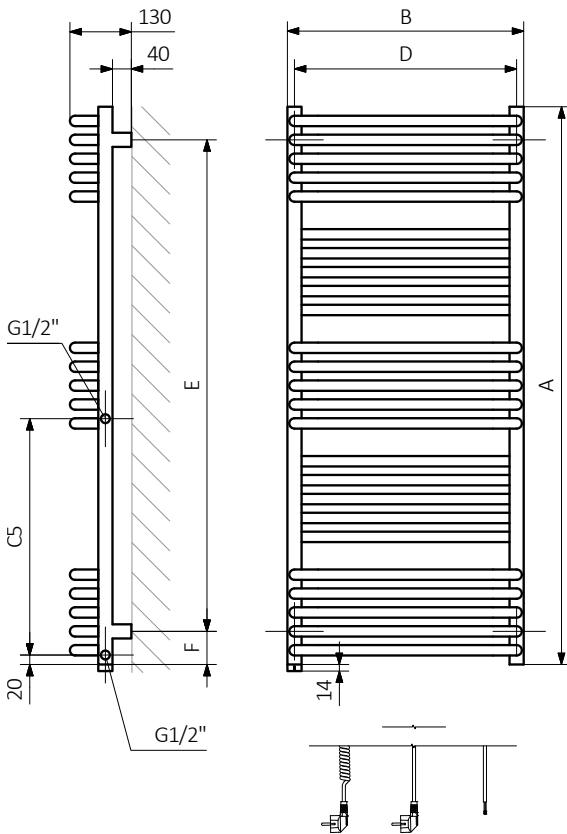
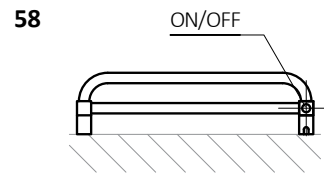
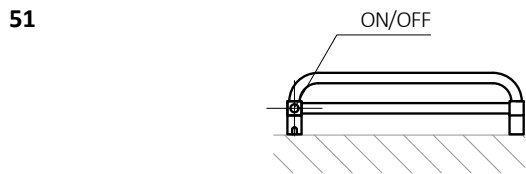
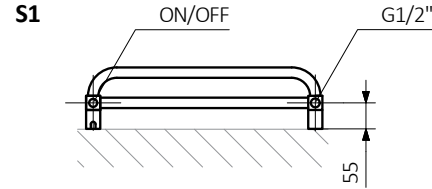
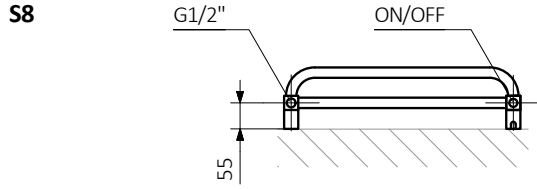
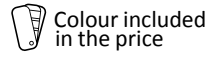

A — Height B — Width C1-C5 — Distance between pipe centres D — Horizontal distance between mounting bracket centres
E — Vertical distance between mounting brackets F — Distance between a mounting bracket and the bottom of the radiator

Collector:

Profile:

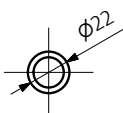
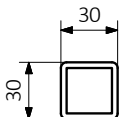

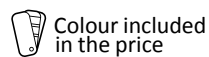

Colour included
in the price

Product codes can be found in product data sheet tables. The codes provide some basic information about the product while a partially filled configuration code contains complementary information about the detailed specifications. When placing an order, product codes should include the fully completed configuration part. The configuration code part should be placed after the main product code. The main product code and configuration part will appear as shown in the example below:

The Construction of the product and configuration code for a radiator with the built-in heating element ONE

WWBNN076050

K916E1W

PRODUCT CODE
(located in the table for the product)

CONFIGURATION CODE
(supplemented by hand)

Configuration

K 916 E1 P

Package code Colour code Connection code Type of heating element cable code
K – carton box

Zinc powder primer

C – Code of zinc powder primer is an extra processes

WLAL054030 K916SX **C** — *Extra processes or additions code*

Pola One

The radiator has a built-in ONE heating element.

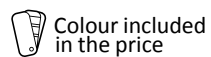

Legend



Available in chrome finish.



Radiator available in a "water" version.



Radiator suitable for dual fuel connection. Electric heating element can be installed.



Radiator available in electric only version. It comes prefilled with a 'heating medium' and equipped with a heating element. All tested and ready to use.



Connection types dedicated for this radiator.

The icon shows the flow and return connections for the radiator as well as the thermostat valve and heating element position if applicable.



Optional connections available for this radiator.



Suggested heating element power output for electric and dual fuel versions.



Weight.



Capacity.